

Horse - Dalas Dimitris

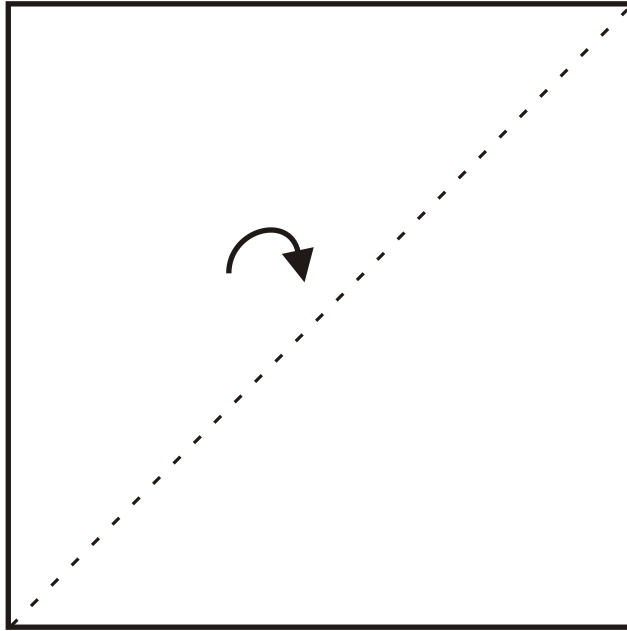

1

Mountain diagonal Fold

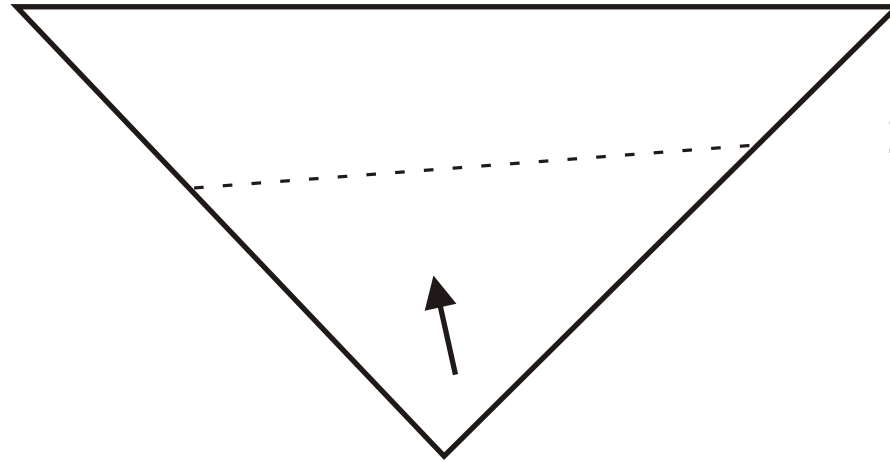

2

Fold the first part of the paper to upwards repeat with the other part behind

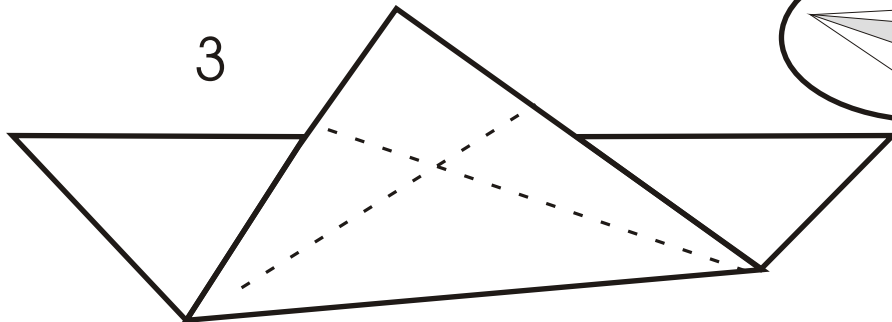

3

Rabbit ear - repeat behind

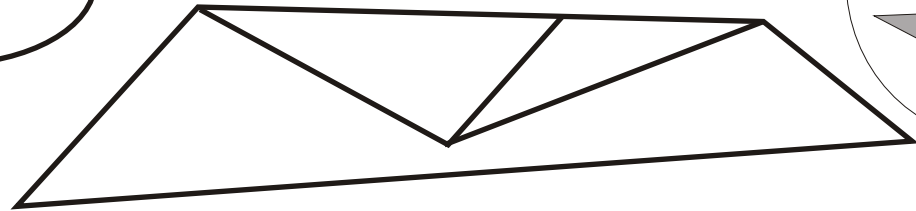
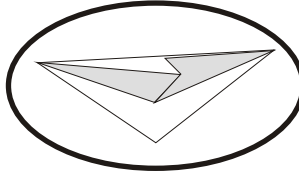

4

Squash fold - repeat behind

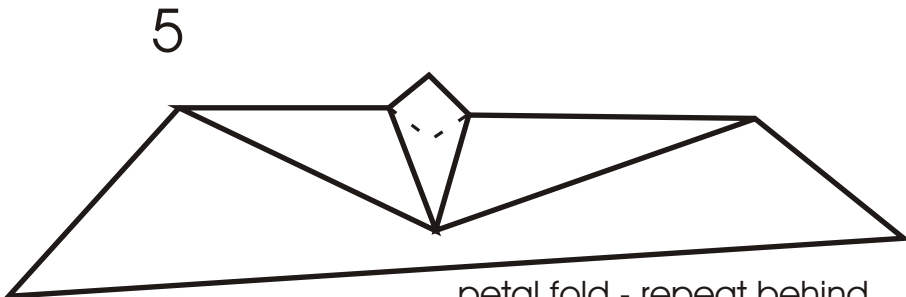
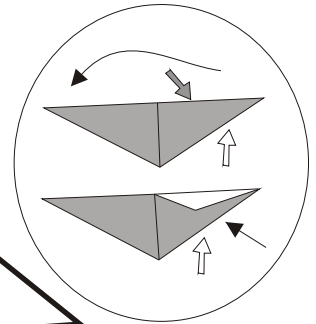

5

petal fold - repeat behind

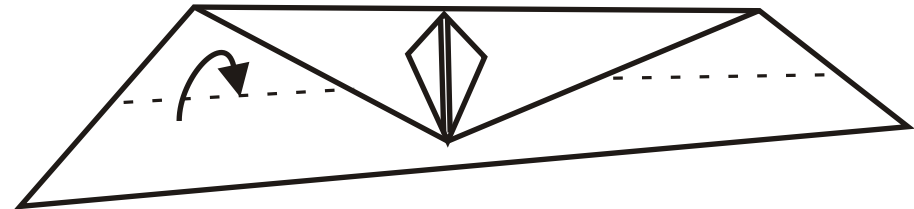

6

fold the paper in the middle - repeat behind

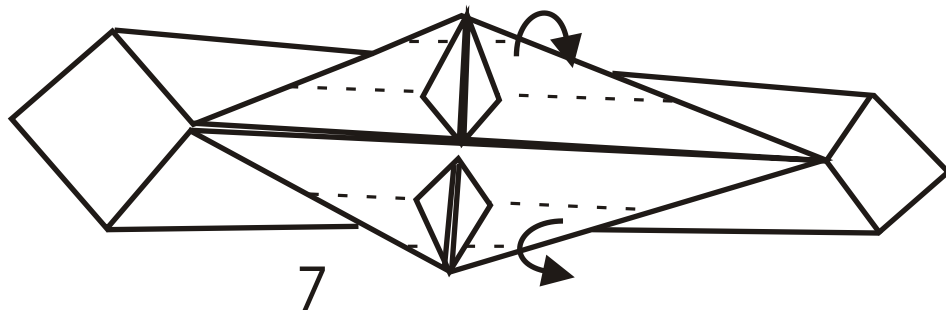

7
Fold the sides to the center
and then pull them out

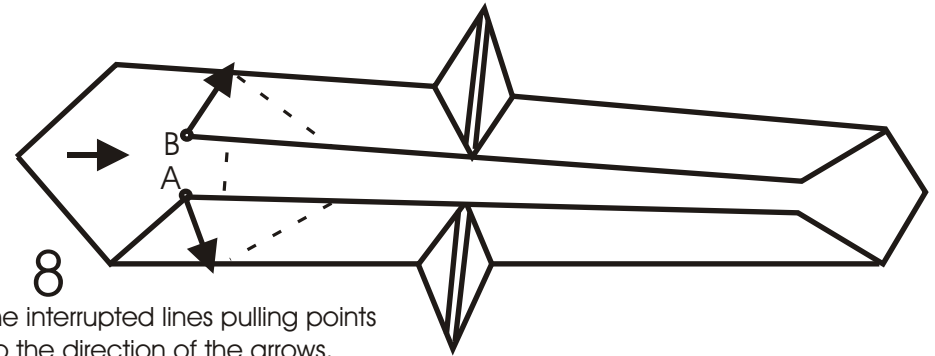

8
Fold as the interrupted lines pulling points
A and B to the direction of the arrows.

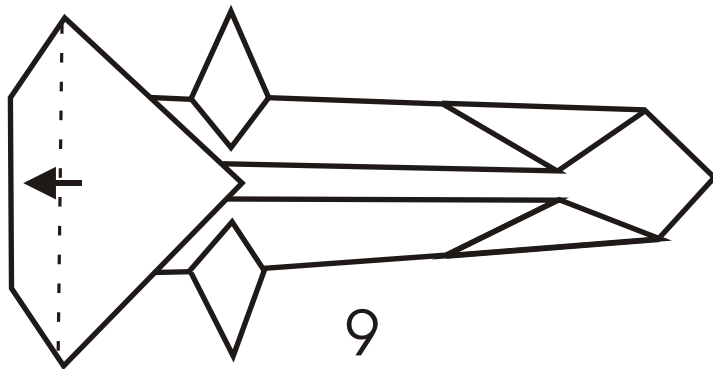

9
Fold at the point of the interrupted line
above to the direction of the arrow

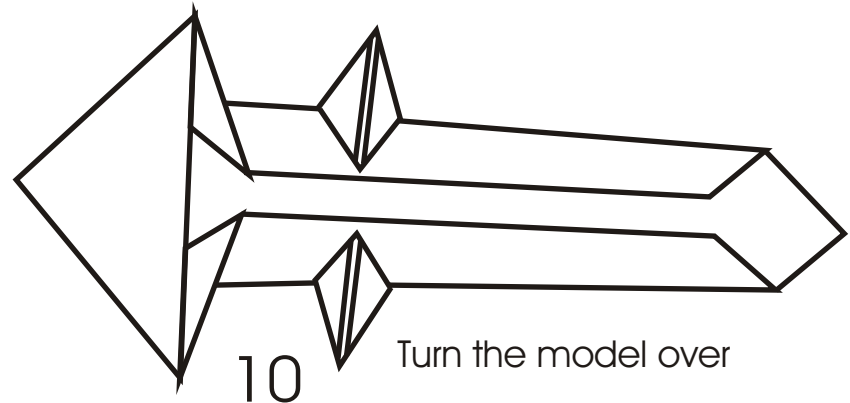

10
Turn the model over

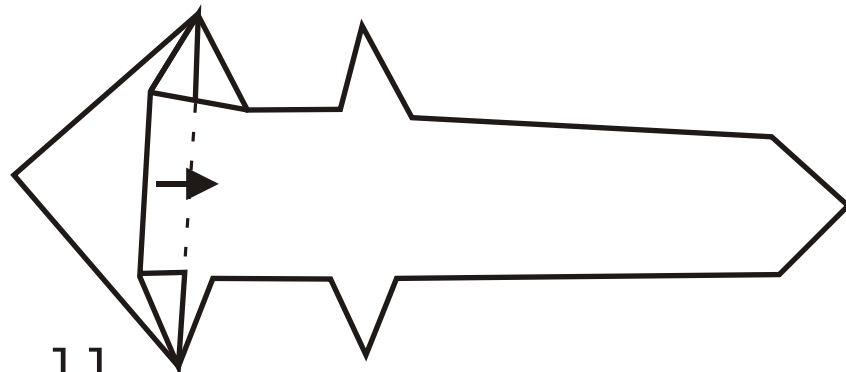

11
Fold at the point of the interrupted line
above to the direction of the arrow

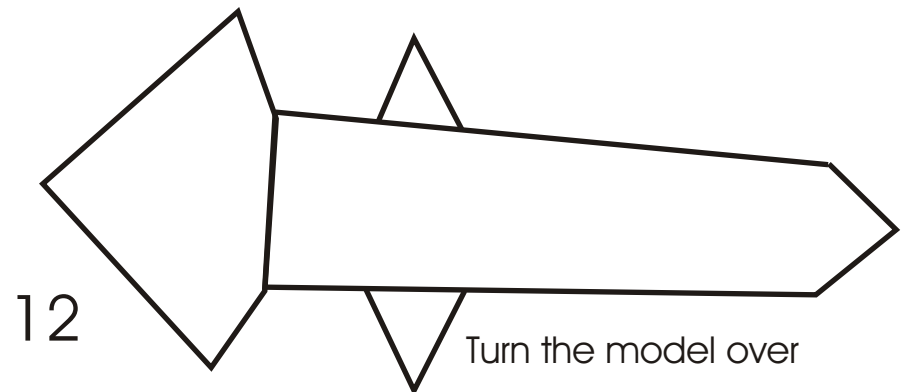

12
Turn the model over

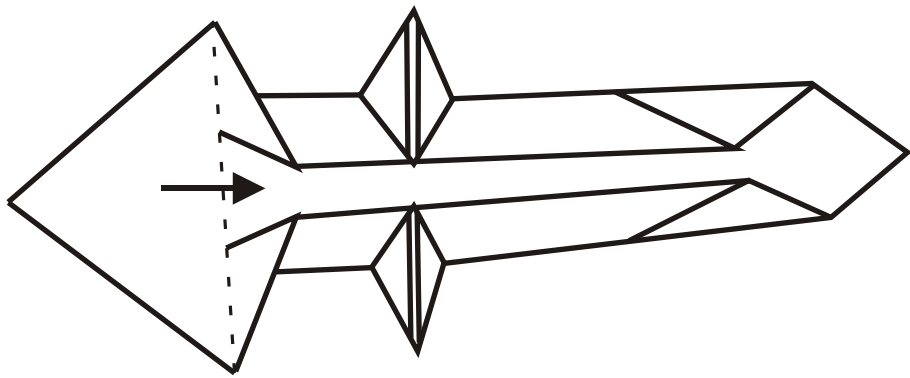

13 Fold at the point of the interrupted line above to the direction of the arrow

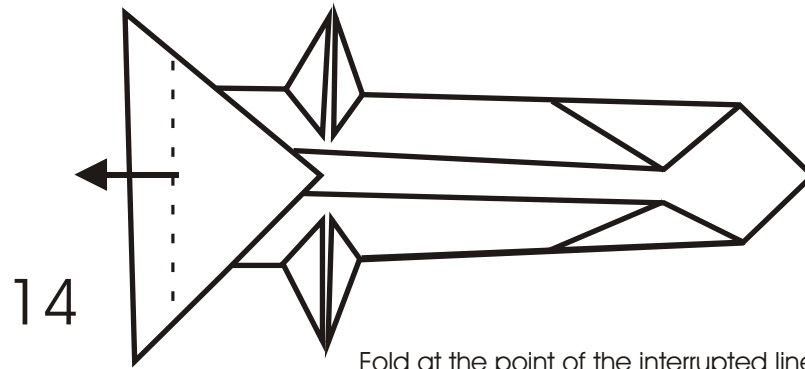

14 Fold at the point of the interrupted line above to the direction of the arrow

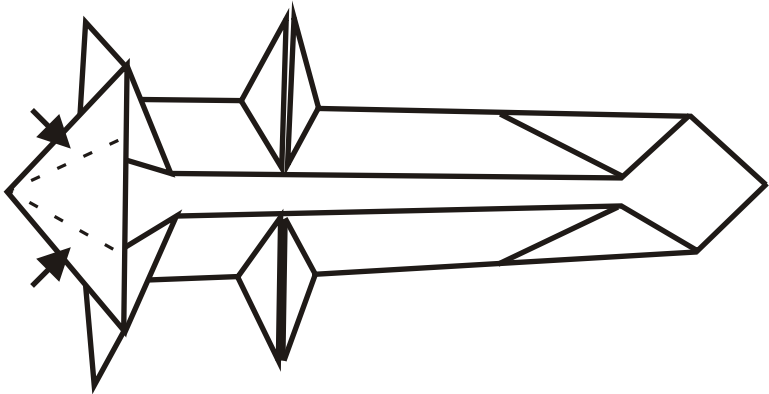

15 Fold the arrows show in order to create form 16

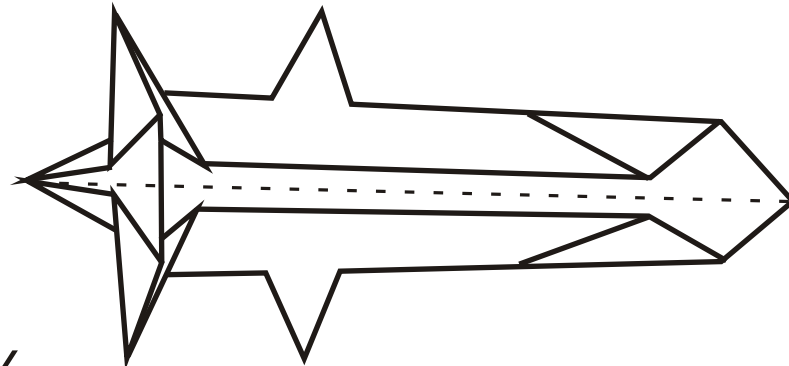

16 fold the model in the middle

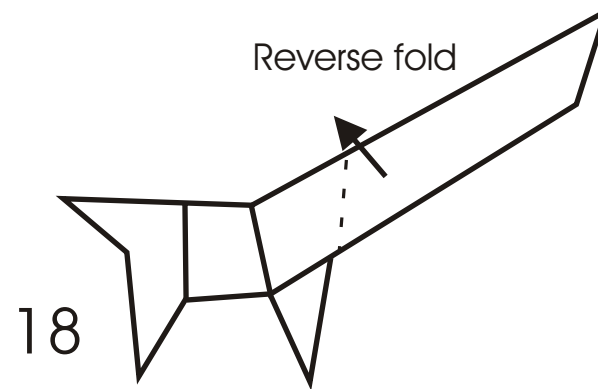
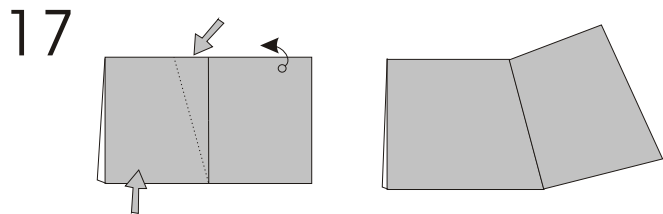
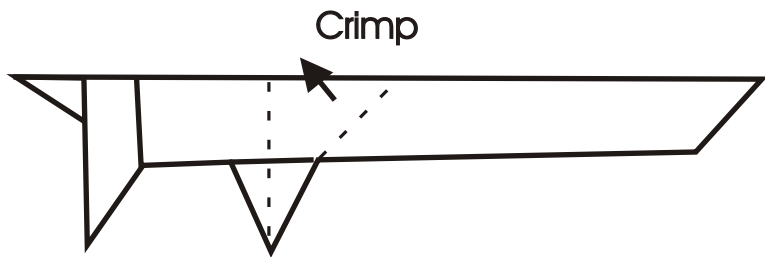

18

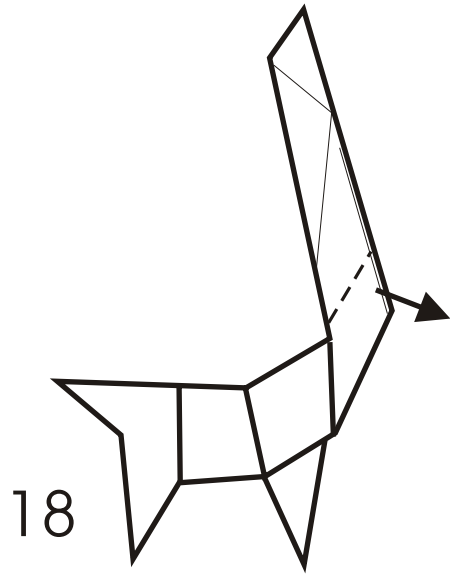

Reverse fold

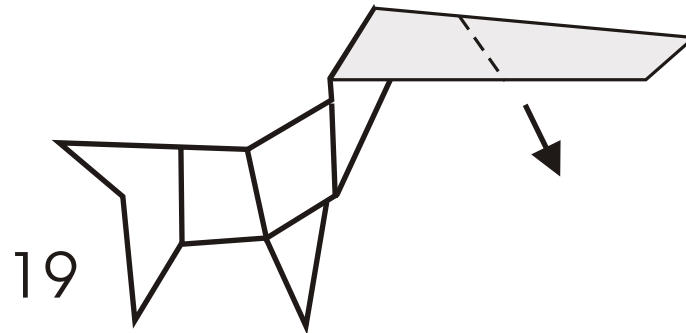

Reverse fold

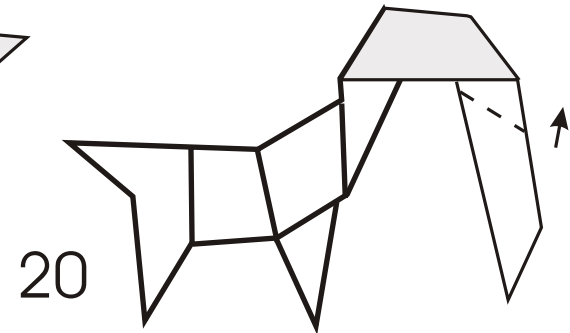

Reverse fold

